



Ornametals

WWW.ORNAMETALS.COM • (256) 255-0190 • 140 COUNTY ROAD 1311 • CULLMAN, AL 35058

EuroGutterUSA™

Ornaments

Historic Restoration

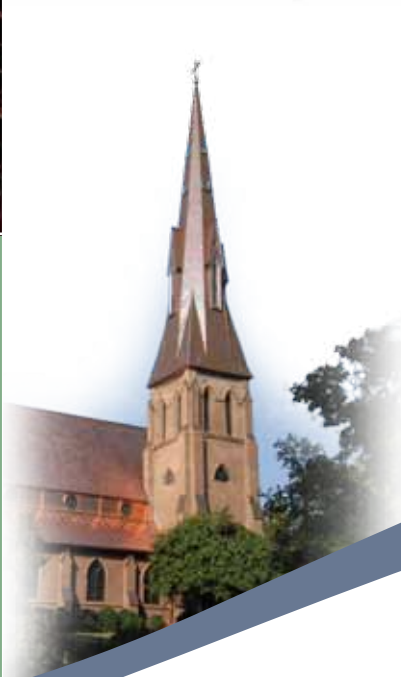

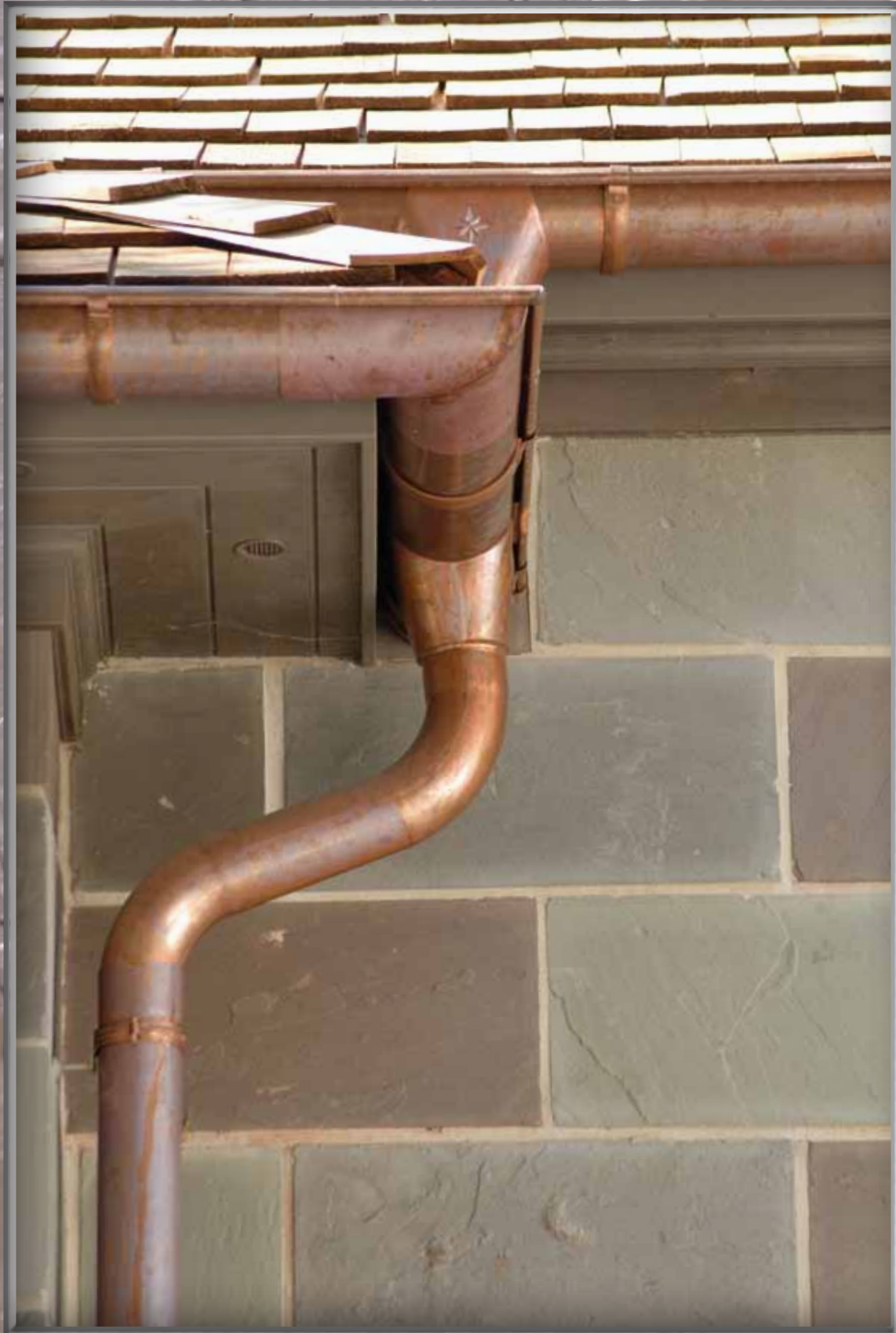

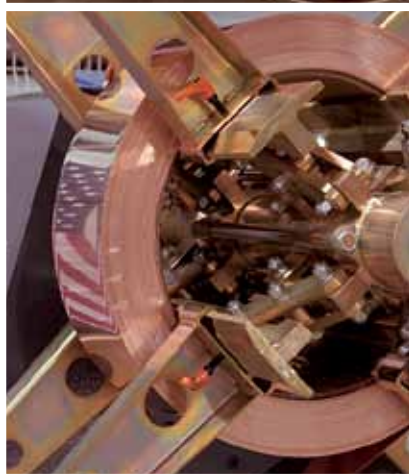

EuroGutterUSA™

With its top-of-the-line roll forming equipment and 27,500 square foot manufacturing facility located in Cullman, Alabama, Ornametals is the only U.S. manufacturer of a complete line of European-style, sustainable rainwater goods. To complement the EuroGutterUSA™ line, Ornametals also offers radius gutters and custom roof ornaments, finials, leaderheads, chimney caps, flashing and more.

Specifications, Installation Guide, and Installation Video available at www.ornametals.com.



A Complete Rainwater Drainage System by Ornametals

Ornametals offers EuroGutterUSA™, a complete line of European-style, sustainable rainwater goods manufactured in the U.S. Featuring half-round gutter and seamless weld downspouts made from copper and VMZINC®, EuroGutterUSA™ includes a full line of complementary accessories such as hangers, brackets, endcaps, elbows and more.

Specifications, Installation Guide, and Installation Video available at www.ornametals.com.

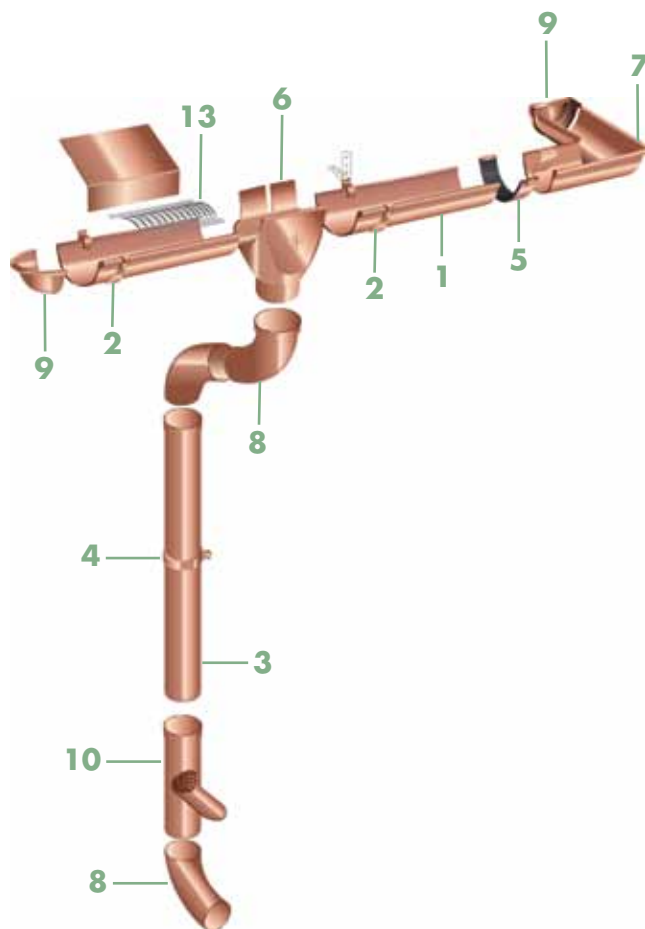

1 Gutters

Half Round



2 Downspouts

Seamless Weld



3 Hangers

Fascia



Roof Mount



4 Downspout Brackets

Bracket with Bolt Screw



Bracket with Pin



5 Gutter Connector



6 Star & Basic Outlets



7 Miters/Corners (Inside & Outside)

Inside



Outside



8 Elbows

40 Degree



72 Degree



85 Degree



9 End Caps

Soldered



Spherical



10 Inline Cleanouts/ Droupouts



11 Expansion Joints

Expansion Coil



Expansion Joint



Other Styles Available

12 Guards & Strainers

Leaf Strainer



Leaf Guard

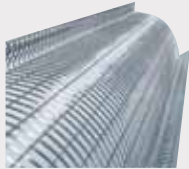

Custom Orders

Leaderheads – Various Styles



Chimney Flashing



Flashing



Swiss Elbow



Radius Gutter



Circular Extension



Corner Extension with Outlet



Other Styles Available





Architectural Ornaments

While architectural ornaments embellish and adorn a building's structural design, they also form an integral part of a structure's framework. Types of ornaments include decorative pieces such as dormers, finials, leaderheads, panels, moldings, roof cresting and medallions, and also structural elements such as roof and chimney flashing, ridge and dormer vents, and chimney caps.



Standard and Custom Ornaments

Working together with Kaufmann GmbH and Umicore Building Products, Ornametals offers a full-range of architectural ornaments in copper and VMZINC® including dormers, finials, leaderheads, panels, moldings, roof cresting, medallions, roof and chimney flashing, ridge and dormer vents, and chimney caps. Ornametals offers custom design and can fabricate ornaments to specification.



Finials



Chimney Caps



Leaderheads



Dormers



Weathervanes

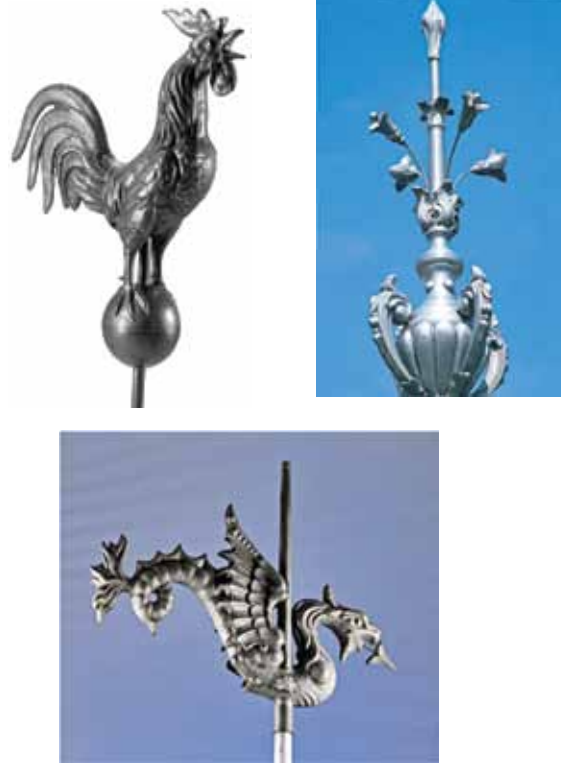

Molding



Medallions



Roof Cresting & Ridge Caps



Decorative Panels

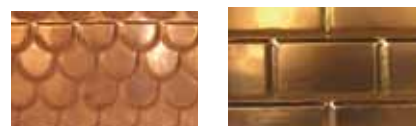



Copper finials and dormers adorn Temple B'Nai Shalom in Huntsville, Alabama.
The architectural ornaments were painted white for historical accuracy.



Historic Restoration and Preservation

Ornametals fabricates, restores and preserves custom copper and zinc roofing systems, cupolas, finials, towers and other architectural elements for projects throughout the world. We utilize techniques that have been passed down for hundreds of years, along with modern methods and equipment. Contact us for more information about our restoration and preservation services.



Offered by:

140 County Road 1311 • Cullman, AL 35058
P (256) 255-0190 • F (256) 255-0195

www.ornametals.com

Made in the USA • European Style • Sustainable Products